



UM18-211126112

UM18

ULTRASONIC DISTANCE SENSORS

SICK
Sensor Intelligence.



Ordering information

| Type | Part no. |
|----------------|----------|
| UM18-211126112 | 6048393 |

Other models and accessories → www.sick.com/UM18



Detailed technical data

Mechanics/electronics

| | |
|--|--|
| Supply voltage V_s | DC 10 V ... 30 V ¹⁾ |
| Power consumption | ≤ 1.2 W ²⁾ |
| Initialization time | < 300 ms |
| Design | Cylindrical |
| Housing material | Metal (nickel-plated brass, ultrasonic transducer: polyurethane foam, glass epoxy resin) |
| Thread size | M18 x 1 |
| Connection type | Male connector, M12, 5-pin |
| Indication | 2 x LED |
| Weight | 30 g |
| Sending axis | Angled |
| Dimensions (W x H x D) | 18 mm x 18 mm x 68.7 mm |
| Enclosure rating | IP65 / IP67 |
| Protection class | III |

¹⁾ Limit values, reverse-polarity protected Operation in short-circuit protected network: max. 8 A, class 2.

²⁾ Without load.

Safety-related parameters

| | |
|-------------------------|-----------|
| MTTF_D | 101 years |
| DC_{avg} | 0% |

Performance

| | |
|--|--------------------------|
| Operating range, limiting range | 30 mm ... 250 mm, 350 mm |
| Target | Natural objects |
| Resolution | ≥ 0.069 mm |
| Repeatability | ± 0.15 % ¹⁾ |

¹⁾ In relation to the current measured value, minimum value ≥ resolution.

²⁾ Referring to current measurement value.

³⁾ Temperature compensation can be switched off, without temperature compensation: 0.17 % / K.

⁴⁾ Subsequent smoothing of the analog output, depending on the application, may increase the response time by up to 200 %.

| | |
|---------------------------------------|---|
| Accuracy | $\pm 1\%$ ^{2) 3)} |
| Temperature compensation | ✓ |
| Response time | 32 ms ⁴⁾ |
| Output time | 8 ms |
| Ultrasonic frequency (typical) | 320 kHz |
| Additional function | Teach-in of analog output Invertable analog output Multifunctional input: external teach / synchronization / multiplexing Synchronization of up to 20 sensors Multiplexing: no cross talk of up to 20 sensors Reset to factory default |

1) In relation to the current measured value, minimum value \geq resolution.

2) Referring to current measurement value.

3) Temperature compensation can be switched off, without temperature compensation: 0.17 % / K.

4) Subsequent smoothing of the analog output, depending on the application, may increase the response time by up to 200 %.

Interfaces

| | |
|-----------------------------------|--|
| Analog output | |
| Number | 1 |
| Type | Current output |
| Current | 4 mA ... 20 mA, $\leq 500\ \Omega$ ¹⁾ |
| Resolution | 12 bit |
| Multifunctional input (MF) | 1 x MF |

1) For 4 mA ... 20 mA and $V_s \leq 20\text{ V}$ max. load $\leq 100\ \Omega$.

Ambient data

| | |
|---------------------------------------|-------------------|
| Ambient temperature, operation | -25 °C ... +70 °C |
| Ambient temperature, storage | -40 °C ... +85 °C |

Classifications

| | |
|-----------------------|----------|
| ECLASS 5.0 | 27270804 |
| ECLASS 5.1.4 | 27270804 |
| ECLASS 6.0 | 27270804 |
| ECLASS 6.2 | 27270804 |
| ECLASS 7.0 | 27270804 |
| ECLASS 8.0 | 27270804 |
| ECLASS 8.1 | 27270804 |
| ECLASS 9.0 | 27270804 |
| ECLASS 10.0 | 27270804 |
| ECLASS 11.0 | 27270804 |
| ECLASS 12.0 | 27272806 |
| ETIM 5.0 | EC001846 |
| ETIM 6.0 | EC001846 |
| ETIM 7.0 | EC001846 |
| ETIM 8.0 | EC001846 |
| UNSPSC 16.0901 | 41111960 |

Dimensional drawing (Dimensions in mm (inch))

UM18-2xxxxx2

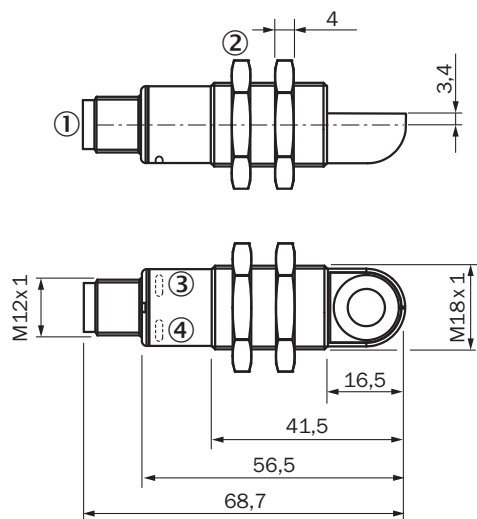

- ① Connection
- ② Fixing nuts, width 24 mm
- ③ Status display for supply voltage active (green)
- ④ Status indicator switching/analog output (orange)

Connection type

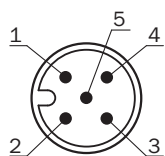

Connection diagram

UM18-21xxx6xxx UM18-21xxx7xxx Connector M12, 5-pin

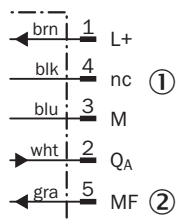

- ① Not assigned
- ② Multifunctional input/synchronization and multiplex operation/communication Connect+

Detection area



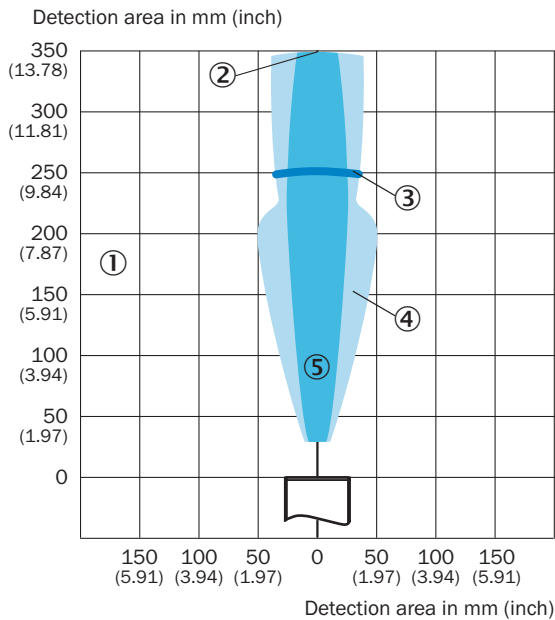

UM18-211



- ① Detection range dependent on reflection properties, size, and alignment of the object
- ② Limiting range
- ③ Operating range
- ④ Example object: aligned plate 500 mm x 500 mm
- ⑤ Example object: cylindrical bar with a diameter of 10 mm

Recommended accessories

Other models and accessories → www.sick.com/UM18

| | Brief description | Type | Part no. |
|---|---|------------------------|----------|
| Cloning modules | | | |
|  | Tool for visualization, configuration and cloning, 3-digit LED display, supply voltage: DV 9 V ... 30 V | Connect+ adapter (CPA) | 6037782 |
| Deflector mirrors | | | |
|  | 90° sound deflection plate for UM18-1xxxx and UM18-2xxxx, stainless steel, for straight versions | USP-UM18 | 5323658 |
| Mounting brackets and plates | | | |
|  | Mounting plate for M18 sensors, steel, zinc coated, without mounting hardware | BEF-WG-M18 | 5321870 |
|  | <ul style="list-style-type: none"> • Connection type head A: Female connector, M12, 5-pin, straight, A-coded • Connection type head B: Flying leads • Signal type: Sensor/actuator cable • Cable: 2 m, 5-wire, PVC • Description: Sensor/actuator cable, unshielded • Application: Zones with chemicals | YF2A15-020VB5XLEAX | 2096239 |

SICK AT A GLANCE

SICK is one of the leading manufacturers of intelligent sensors and sensor solutions for industrial applications. A unique range of products and services creates the perfect basis for controlling processes securely and efficiently, protecting individuals from accidents and preventing damage to the environment.

We have extensive experience in a wide range of industries and understand their processes and requirements. With intelligent sensors, we can deliver exactly what our customers need. In application centers in Europe, Asia and North America, system solutions are tested and optimized in accordance with customer specifications. All this makes us a reliable supplier and development partner.

Comprehensive services complete our offering: SICK LifeTime Services provide support throughout the machine life cycle and ensure safety and productivity.

For us, that is “Sensor Intelligence.”

WORLDWIDE PRESENCE:

Contacts and other locations –www.sick.com